

4

3

2

1

THIS DRAWING IS UNPUBLISHED.

RELEASED FOR PUBLICATION

© COPYRIGHT 19 BY -

ALL RIGHTS RESERVED.

LOC ES DIST 00

REVISIONS

| P | LTR | DESCRIPTION | DATE | DWN | APVD |
|---|-----|-------------|------|-----|------|
|   |     |             |      |     |      |

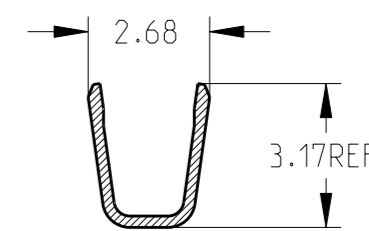
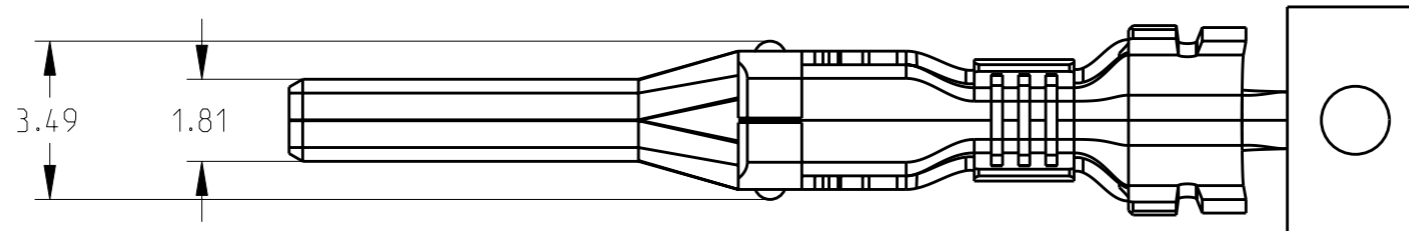

SECTION A-A

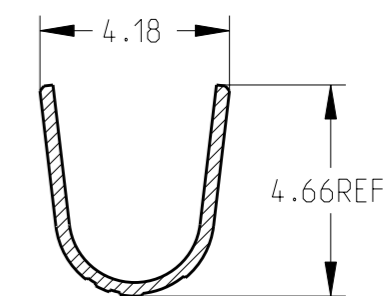
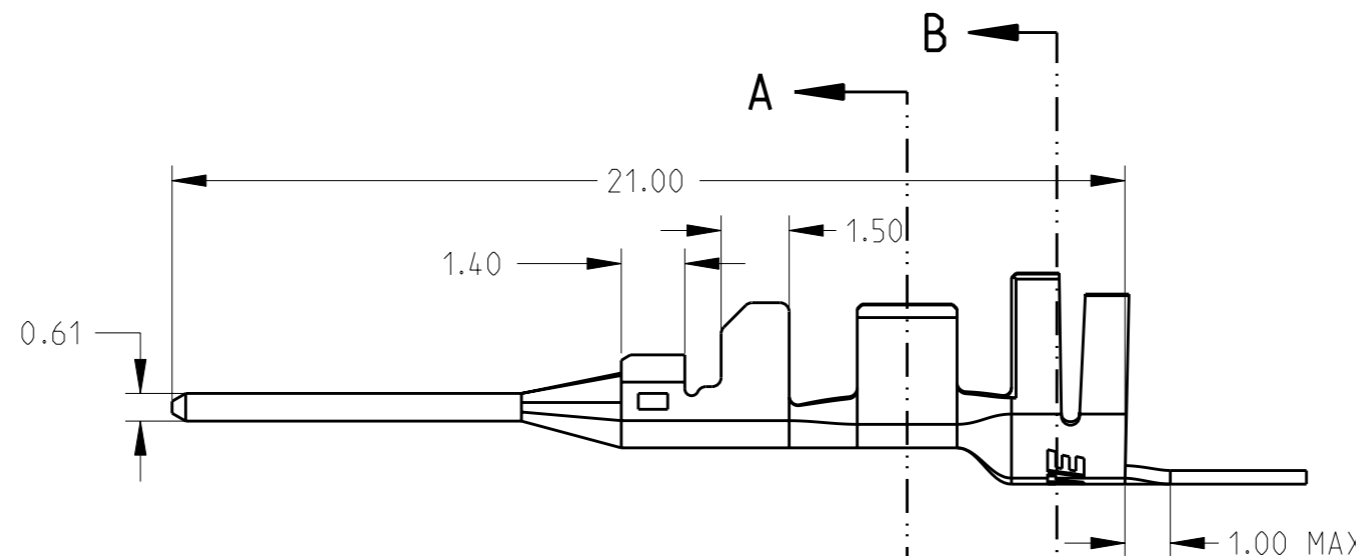
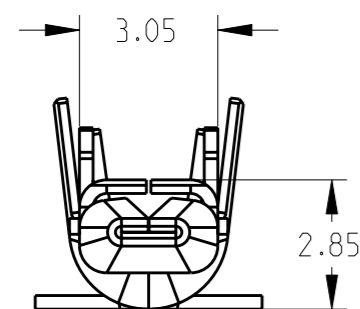

SECTION B-B

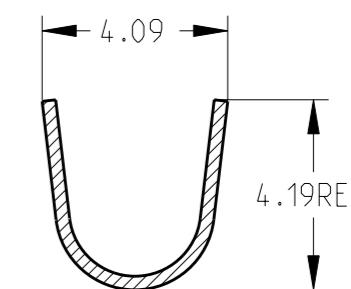
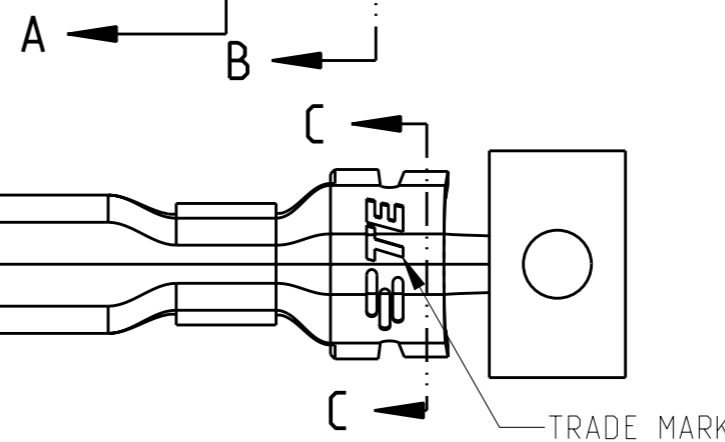

SECTION C-C

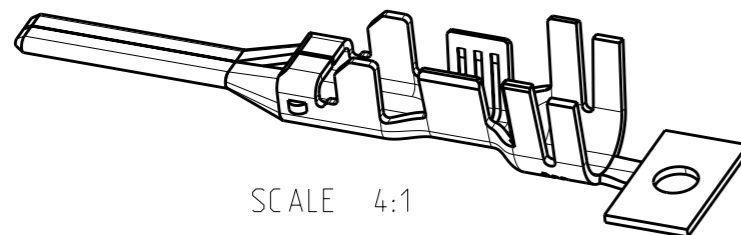

SCALE 4:1

NOTE:  
 1.MATERIAL:COPPER ALLOY.PRE-TINNED  
 2.APPLICABLE HOUSING P/N:1983658-\*,1983659-  
 3.APPLICABLE WIRE RANGE:16~20AWG

PART NUMBER 1983661-1

|   |          |  |   |
|---|----------|--|---|
| THIS DRAWING IS A CONTROLLED DOCUMENT.  |          | DWN LEO LIU 19AUG2011  |  TE Connectivity                           |
| DIMENSIONS: mm  |          | CHK HAPYE WU 19AUG2011   |   |
| TOLERANCES UNLESS OTHERWISE SPECIFIED:  |          | APVD ERIC KONG 19AUG2011   |   |
| 0 PLC ±<br>1 PLC ±1.0<br>2 PLC ±0.50<br>3 PLC ±0.300<br>4 PLC ±0.2000<br>ANGLES ± |          | PRODUCT SPEC 108-106071<br>APPLICATION SPEC 114-106071<br>WEIGHT - |   |
| MATERIAL -  | FINISH - | CUSTOMER DRAWING   | NAME TAB CONTACT MULTI 6P CONNECTOR<br>SIZE A3 CAGE CODE - DRAWING NO C=1983661 RESTRICTED TO -<br>SCALE 6:1 SHEET 1 OF 1 REV A |